

GAMMA[®]

X-STRINGER

X-6FC STRINGING MACHINE



OWNER'S MANUAL

Issue 5 - June 2014

GAMMA®

X-STRINGER

X-6FC

MGX6F-12 OWNER'S MANUAL

TABLE OF CONTENTS

WARRANTY	PAGE 3
FEATURES	PAGE 4
ASSEMBLY INSTRUCTIONS	PAGE 5
MOUNTING THE FRAME	PAGE 7
STRINGING THE FRAME	PAGE 9
ADDITIONAL FEATURES	PAGE 13
PATHFINDER AWL	PAGE 14
MAINTENANCE & ADJUSTMENTS	PAGE 15
TROUBLESHOOTING TIPS	PAGE 16
NOTES	PAGE 17
PARTS LIST	PAGE 18
PARTS DRAWING	PAGE 19

LIMITED WARRANTY

GAMMA Sports (GAMMA) warrants to the original purchaser that the X-STRINGER stringing machine ("EQUIPMENT") purchased is free from defects in materials and workmanship for a period of five (5) years from the date of original purchase for mechanical parts (excluding any electrical parts and string clamps), and for a period of one (1) year from the date of purchase for any electrical parts and string clamps. Should any defects develop under normal use within the specified time periods, GAMMA will at its option, repair or replace the defective EQUIPMENT provided it is returned to GAMMA prepaid at the purchaser's expense. This warranty does not apply to any damage or defect caused by negligence, abuse, misuse, unauthorized alteration, shipping, handling, or part wear and tear as a result of normal use.

Routine maintenance, adjustment, and cleaning required to ensure proper operation are the responsibility of the purchaser and are not covered under the terms of this warranty. These include, but are not limited to: String Clamp adjustment, as described on page 15, Turntable Bushing Adjustment, as described on page 15 and the Rotational String Gripper.

GAMMA's obligation under this warranty is limited to repair or replacement of defective EQUIPMENT, and no one is authorized to promise any other liability. GAMMA shall in no event be liable for any incidental or consequential damages.

To return defective EQUIPMENT, a return authorization (RA#) must be obtained from a GAMMA customer service representative. The RA# must be marked on the outside of the shipping carton being returned. All returns must be shipped prepaid by the customer to GAMMA. Please retain the original shipping carton and packing materials for any future shipments. GAMMA will not be responsible for machines which are not sent in the original undamaged packaging.

A GAMMA Care Service Plan is also available through GAMMA customer service, call 800.333.0337 for details.

FEATURES



MACHINE FEATURES

- ❖ Drop Weight Tensioner with 8 to 90 lbs Tension Range and Permanently Engraved Weight Scale
- ❖ Professional Six Point “Quick Mount” Racquet Mounting System- Accommodates All Racquets
- ❖ Professional “Quick Action” Dual Action, Rotating, Metal Fixed String Clamps with Diamond Dust Coating
- ❖ Parallel Jaw Rotating Ratchet Gripper with Diamond Dust Coated Gripping Surfaces
- ❖ High Strength Extruded Aluminum Base with Durable Anodized Finish and Convenient Padded Tool Tray
- ❖ Unique Internal Drawer System for Storing Tools and Adaptors

ASSEMBLY INSTRUCTIONS

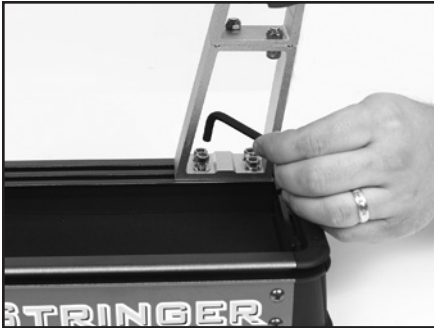

Winder Support Stand Installation

Remove the M5 bolts from the 2 brackets located in the rear slots of the machine base using the 5MM hex key. Slide the brackets to the right end of the base and position the winder stand over the brackets aligning the holes in the base of the winder stand with the holes in the brackets. Attach the winder support stand using the M5 bolts. Install all 4 bolts loosely at first and then tighten all securely.

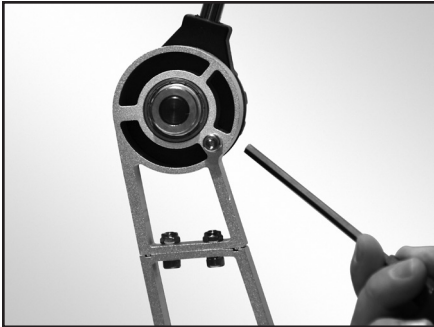

Engaging the Drop Weight Bar Stop

The stringing machine is shipped with the drop weight bar in the horizontal position. To limit the rotation of the drop weight bar and prevent racquet damage during stringing, the bar stop must be engaged.

Hold the drop weight bar in the vertical position as shown while turning the 5mm stop screw located on the back side of the winder stand clockwise.

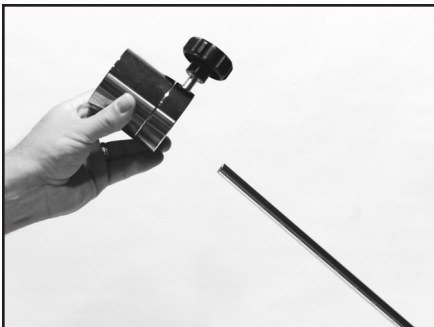

Installing the Drop Weight

Remove the end cap from the tension bar and slide the drop weight onto the bar. The weight should be oriented with the knob end closest to the string winder. Replace the end cap.

ASSEMBLY INSTRUCTIONS

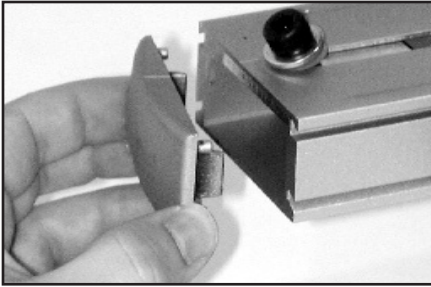

Support Post Installation

To install the support posts you must first remove the turntable end cap by grasping the sides of the end cap and removing it, to gain access to the inside of the turntable.

Repeat procedure on the opposite side of the turntable.

If end caps are tight, a flat blade screw driver may be used to pry the end caps off.

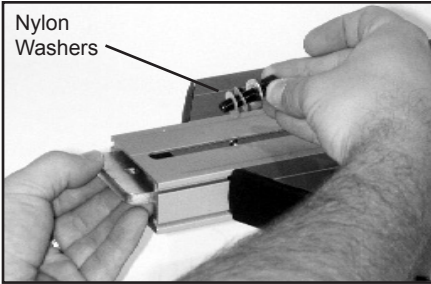

Remove Mounting Bolts

While holding the mounting plate on the inside of the turntable remove the support post mounting bolts.

Note: There are two Nylon washers that are included for shipping purposes only. Remove and discard the nylon washers.

Repeat procedure on the opposite side of the turntable

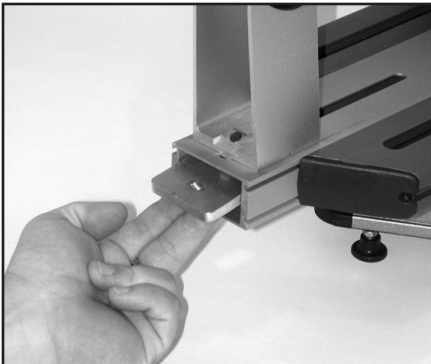

Installing the Frame Support Posts

Place the support post onto the central slot of the turntable. While holding the mounting plate against the inside top surface of the turntable with your fingers, align the hole in the support post with the hole in the mounting plate. Install the mounting bolt through the support post and into the plate by hand and tighten with the 6 mm hex wrench. Re-install the turntable end caps.

Repeat procedure on the opposite side of the turntable

ASSEMBLY INSTRUCTIONS



String Clamp Installation

The post of the string clamp and tube of the string clamp base are treated with grease to provide protection against corrosion during shipping. Remove any excessive grease with a clean cloth prior to use. The post and tube may also be cleaned with isopropyl alcohol. After this type of thorough cleaning, the post and tube should be treated with a light coating of machine oil to protect the surfaces against corrosion and to ensure smooth operation.

MOUNTING THE FRAME

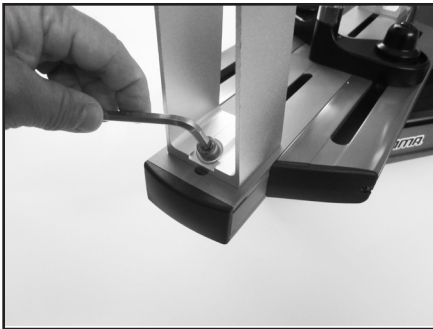

Adjusting the Frame Support Posts

Loosen the lock bolts of the frame support posts and space them apart with the frame support slides separated by the approximate length of the racquet head. Although it is not required, it is good practice to center the support posts on the turntable. Lock one of the posts in position by tightening the lock bolt and position the other post until the frame support slide is positioned near the inside surface of the racquet frame. Securely tighten the lock bolt of the second support post.

Caution: To avoid racquet damage, the center posts should not contact the racquet prior to locking down the support posts.

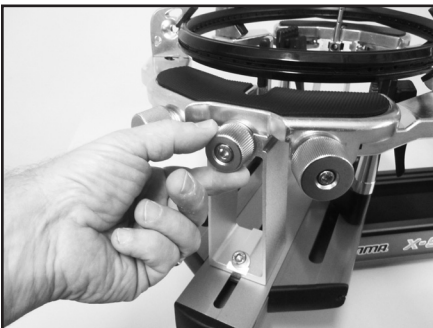

Tightening the Frame Supports

Tighten the Frame Support Slides by turning the adjustment knob clockwise until snug against the racquet frame and slight resistance is felt.

Caution: Overtightening the Center Supports will stretch the head of the racquet and could cause racquet damage.

MOUNTING THE FRAME

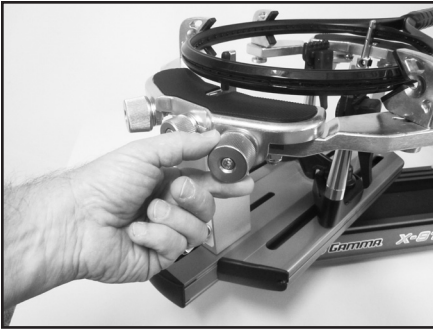

Frame Shoulder Support Arm Adjustment

Being sure the shoulder supports are free to swivel in their mountings, simultaneously rotate the shoulder support adjustment knobs clockwise until both shoulder supports gently and squarely contact the frame.



Frame Shoulder Support Adjustment

The shoulder supports are designed to rotate and can be adjusted to provide maximum support to the racquet frame. Rotate the support so that the pads contact the frame squarely when the arms are closed against the racquet.

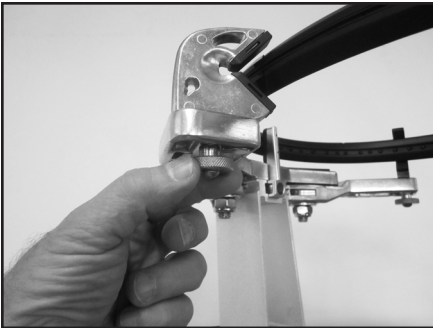

Securing the Frame

Lock the shoulder supports in position by turning the knob at the base clockwise.

Repeat the adjustment procedure for the remaining support post.

Re-tighten all of the frame supports in the same order as before.

Do not overtighten any of the supports as racquet damage may occur.

The supports should be tightened to the point where the racquet frame will not move in the mounting system when the handle is grasped and attempts are made to move it. Should any supports lose contact with the frame while stringing they should be re-tightened.

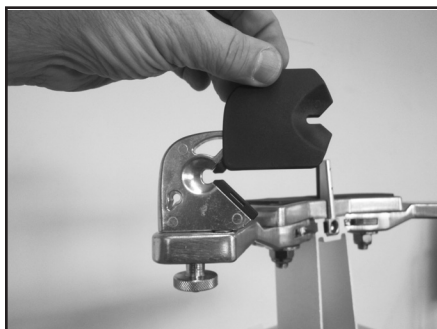

Badminton Shoulder Support Protection Pad Installation

Slide the badminton shoulder support cover over the shoulder supports. There is no need to remove the tennis shoulder supports.

Note: An optional badminton frame support for the head of the racquet is available.

STRINGING THE FRAME



Setting Tension

To set the stringing tension, loosen the locking knob on the side of the drop weight. Slide the weight in the appropriate direction until the face **closest** to the string gripper is indexed with the desired tension mark on the tension bar.

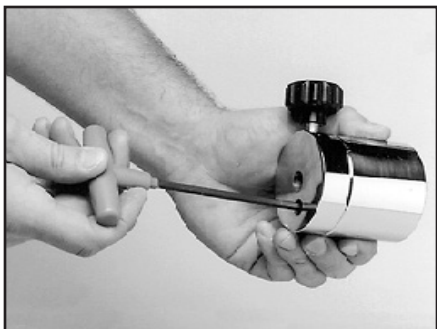

The drop weight is of a two piece design. When assembled, it will accommodate tensions from 20 to 90 lbs For tensions from 8 to 20 lbs, remove the 5mm bolt on the face of the drop weight, and use the smaller portion of the weight as described above.

Note: Tensions above 77lbs require the removal of the drop weight bar end cap.

STRINGING THE FRAME



String Clamp Operation

The fixed clamps are of a dual action design. The string clamp and the clamp base operate independently of one another.

To clamp a string, lift the clamp head and place the string between the jaws. Depress the clamp head lever to secure the string. The clamping pressure applied to the string should be adjusted to provide sufficient pressure to secure the string when subjected to the desired pulling tension. The diamond coated gripper plates provide for increased friction between the clamps and the string to allow for reduced clamping pressure while securing and holding the string under tension.



Base Clamp Operation

Rotate the lever lock clockwise to secure the clamp base to the turntable.

Reverse the clamping procedure to unlock the string clamp.

The lever should be tightened enough to prevent clamp base slippage on the turntable, when the desired tension is placed on the string. To go from the loose position to the clamped position and back, generally requires about 1/2 to 3/4 quarters of a turn. Although when stringing at extremely high tensions, additional tightness may be required.

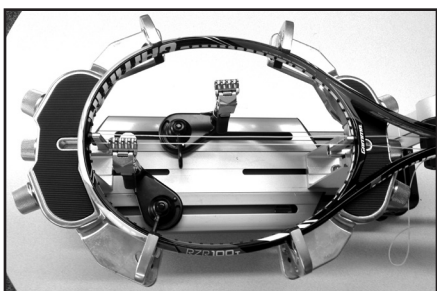

Clamping the First Main String

To begin stringing the main strings, thread the two ends of the string through the two center holes at the appropriate end of the frame and continue through the opposite center holes. Thread one end of the string through the adjacent grommet hole and pull excess by hand.

Secure one of the strings using a string clamp.

STRINGING THE FRAME

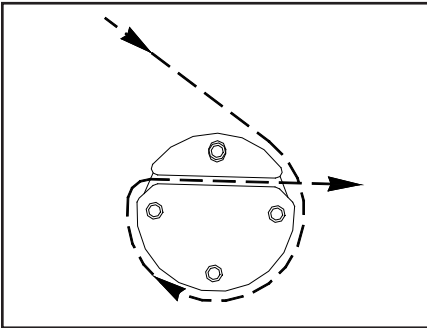

Gripping the String

While holding the tension bar slightly above horizontal, wrap the free string clockwise around the gripper drum once and position between the gripper jaw.

Gently turn the gripper clockwise while squeezing the jaws together until all slack in the string is removed.

Note: For proper operation, the string gripper jaw must be in the position shown. The tension in the string provides the clamping force to the jaws.

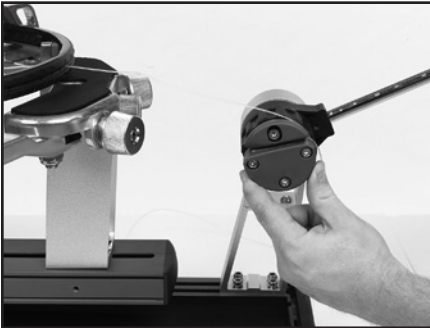

Pulling Tension

While securely holding the string gripper drum with your hand, lift the tension bar above horizontal and gently lower the bar under its own weight. If the tension bar drops below horizontal, repeat the above action until the bar comes to rest parallel to the racquet.

WARNING: TO AVOID INJURY, KEEP FINGERS AWAY FROM GRIPPER JAWS WHILE TENSIONING STRING.



When the correct tension is attained, the drop weight bar will rest horizontally as shown. For accurate tensioning, it must be lowered and come to rest at horizontal without assistance. Manually forcing the tension bar to the horizontal position will greatly increase the string tension and may result in racquet damage. If the tension bar comes to rest above horizontal, release the string by lifting the bar and re-pull the string.

STRINGING THE FRAME

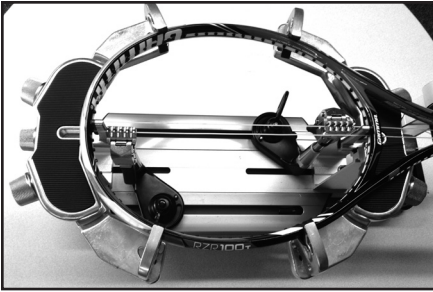

Clamping the String

Secure the tensioned main string using the remaining fixed clamp. Release the string from the gripper by raising the tension arm.

Repeat the procedure for all of the remaining main strings and tie off following the racquet manufacturers recommendations.

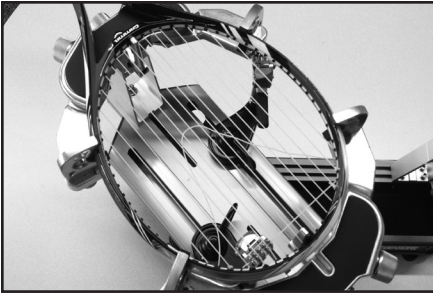

Weaving the Cross Strings

Follow the manufacturer's recommended stringing pattern for one or two piece stringing. This will determine the starting point for the cross strings. If applicable, tie the first cross string using an appropriate starting knot.

Weave the cross strings over and under the main strings being careful to alternate the weave direction of each consecutive cross string so as to be opposite of the previously installed cross string.

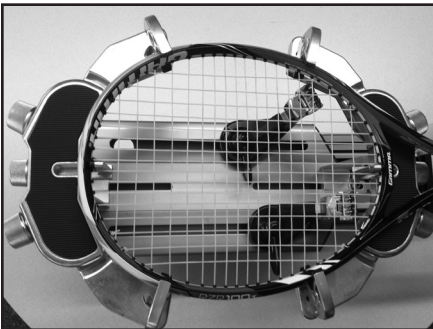

Completing the String Job

Once the final cross string is tensioned and clamped, tie off at the appropriate hole specified by the racquet manufacturer.

Remove the frame from the mounting system by loosening the shoulder supports and frame supports.

ADDITIONAL FEATURES



Storage Drawers

There is one storage drawer located in the base of the machine. The drawer opens from the right side of the base and lock into the end cap with a spring loaded latch.

To open the drawer depress the latch in the face of the drawer and slide it to the right. To close the drawer simply slide the drawer back inside the base and the latch will automatically lock into place.

PATHFINDER AWL



The machine includes the pathfinder stringing awl which creates a pathway between or around strings to make inserting a string through blocked grommets easier and quicker.

Insert the awl through the grommet hole in the same manner as for traditional awls. The Pathfinder awl must be in the closed position before insertion.

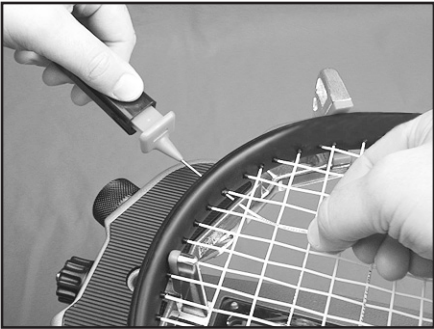

Once the awl is inserted, pull the handle of the awl outward while holding the tip section in place. This leaves the outer sheath in the grommet hole. Insert the end of the string into the outer sheath.

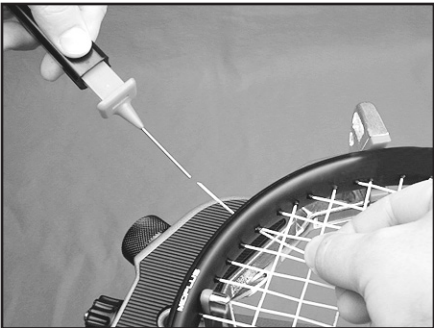

While holding the string, slowly pull the sheath out of the grommet hole to leave the free end of the string exposed.

MAINTENANCE & ADJUSTMENTS



Turntable Bushing Adjustment

The turntable bushing is adjusted at the factory for optimum performance. After time and use, the turntable bushings may need minor adjustment. An adjustment is indicated when noticeable turntable looseness or wobble occurs while stringing.

To adjust the fit between the turntable pin and the bushings, tighten the set screw at the top of the bushing using a 3mm hex wrench. Tighten until the turntable rotates smoothly without excessive free play.

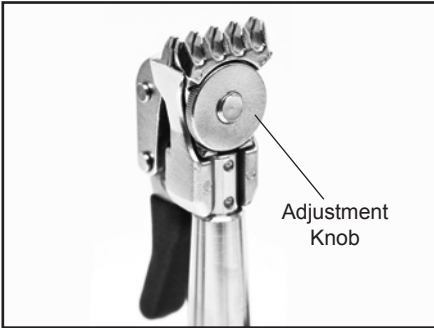

Adjusting the Clamps

The clamps provided with your stringing machine will need minor adjustments according to string type, construction, and gauge. To adjust, route the string through the racquet as if you were beginning the main strings. Clamp the strings and pull tension. If the string slips through the jaws of the clamp, tighten the clamp by turning the adjustment knob opposite of the handle, in the clockwise direction. If the clamp leaves impressions or damages the string, it is too tight and must be adjusted by turning the adjustment knob counterclockwise.

The clamp jaws must be clean and free from dirt, oil, and any string coating for them to grip properly. Clean the clamp jaws with alcohol.

Note: The string clamps supplied with your stringing machine can accommodate tight string patterns such as badminton. Depending on the string pattern, the clamp will spread the strings slightly which will not compromise the quality of the string job.

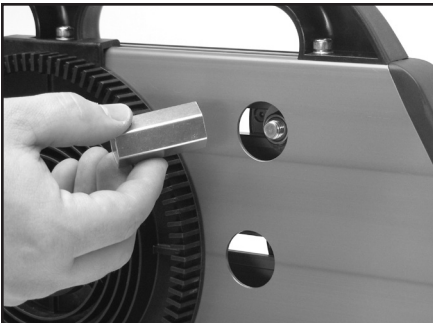

Clamp Base Locking Nut Adjustment

In the event the Locking Lever rotation is insufficient to ensure smooth operation of the clamp base, very minor adjustments to the Clamp Base Locking Nut can be made with the supplied 17mm socket. Tighten or loosen the locking nut in very small increments to provide more clamping pressure or running clearance as needed.

TROUBLESHOOTING TIPS

PROBLEM

SOLUTION

String slips in clamps

- Adjust gap between clamp jaws
- Clean clamp jaws

String slips in gripper

- Clean gripper jaws
- Make sure string is wrapped over top gripper prior to inserting between gripper jaws

String clamp base slips on turntable

- Clean bottom of clamp & top of turntable with alcohol
- Adjust clamp base locking nut

CARE & CLEANING

With time and use, the clamping surfaces of your machine may become oily or dirty and result in string or clamp slippage while stringing. Periodic cleaning of the String Clamps and String Gripper is recommended. Knife sharpening stones work well for cleaning the diamond coated string clamping surfaces. Cleaning with a solvent such as isopropyl alcohol and a mild abrasive tool such as a toothbrush also works well to remove oily or greasy build up.

NOTES

PARTS DRAWING

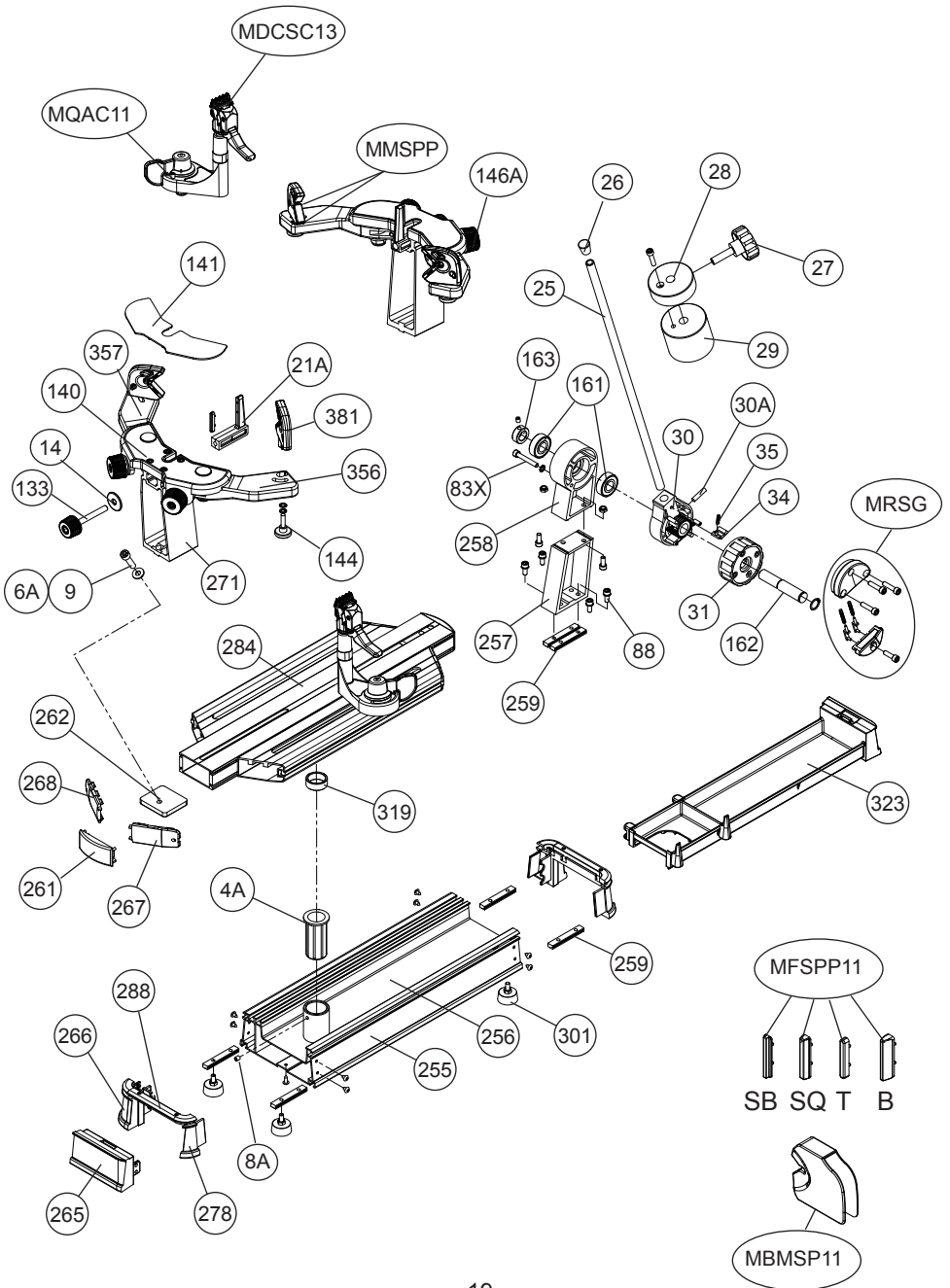



MMAN-45
(MGX6F-13)

GAMMA SPORTS

200 Waterfront Drive
Pittsburgh, Pennsylvania 15222
Phone: 800.333.0337 Fax: 412.323.0317
Visit our website at www.gammasports.com